

xG1W-2

Gateway (DALLAS) through RS485 (Modbus RTU)

1-WIRE



Gateway 1-WIRE (DALLAS) for **measuring temperatures, humidity, with i-button keys** and **communication RS 485 MODBUS RTU**

- **Connection up to 40 temperature sensors with measuring humidity, i-button keys through 2 buses with communication 1-WIRE (DALLAS).
1st bus = 20 temperatures + humidity or i-button keys.**
- **Easy and variable solution for measuring in an object, in technology, remote measurement with the bus.**
- **Unbeatable savings of financial costs for cables compared to other solutions: 20 sensors on one bus (totally 40 sensors/1 unit).**
- **Easy installation into a control cabinet.**
- **Interface RS 485, RS 232, USB**
- **Complete management through the application 1-WIRE-GWY Tool, baud rate and address settings, sensors addressing on positions, values displaying, firmware upgrade and other necessary functions.**
- **Software support = library elements are ready (programs) for control systems of different producers.**



TECHNICAL DATA

Electrical data	power supply range	8-27/DC (tolerance +/- 10%)
	own device consumption	1,5W
	indication	yes, a green LED on the front panel of the device
Communication I.	type	RS 485 (TIA/EIA-485-A), RS-232
	protocol	MODBUS RTU (slave), supported function 03, 06, 16
	baud rate for RS 485 and RS 232	optional (kBd) 1200, 1800, 2400, 4800, 7200, 9600, 14400, 19200, 28800, 38400, 56000, 57600, 76800, 115200, 128000, 230400
	address	1-247
	No. of devices on the bus RS 485	32
	parity	no, even, odd
	stopbit	1,2
	galvanic isolation from the power supply	yes
indication	yes, a yellow LED on the front panel of the device	
Communication II.	type	1-WIRE (DALLAS)
	protocol	1-WIRE (DALLAS)
	No. of temperature sensors on 1 bus	20
	No. of buses (lines)	2
	galvanic isolation from the power supply	yes
Operating values	Indication of the bus state	yes LED
	cover	IP20
	operating temperature	0-40 °C
	relative air humidity	max. 80 %
USB	external dimension (h x w x d)	98 x 17,5 x 56,4mm
	type	USB – pro service purposes
	protocol	MODBUS RTU (slave), supported functions 03, 06, 16
	baud rate	115 200 bps
	address	1
parity	no	

	stop bit	1
	indication	yes, a yellow LED on the front panel of the device

DESCRIPTION OF DEVICE FUNCTIONS

Gateway 1-WIRE-GWY-MOD processes data from temperature sensors or i-button keys with communication 1-WIRE (DALLAS) on its two data buses. Each bus can serve up to 20 temperature sensors with information about humidity (totally 40) and send their values including faulty states through the interfaces RS 485, RS 232 with protocol MODBUS RTU. The gateway is configured through the application 1-WIRE-GWY-TOOL and USB cable for easy and simple management of sensors positions and all necessary settings. LED indicators on the front panel to indicate the power of the device, communication on RS 485, RS 232 and presence of temperature sensor for each bus separately.

EXAMPLE FOR CONNECTION OF THE INTERFACES

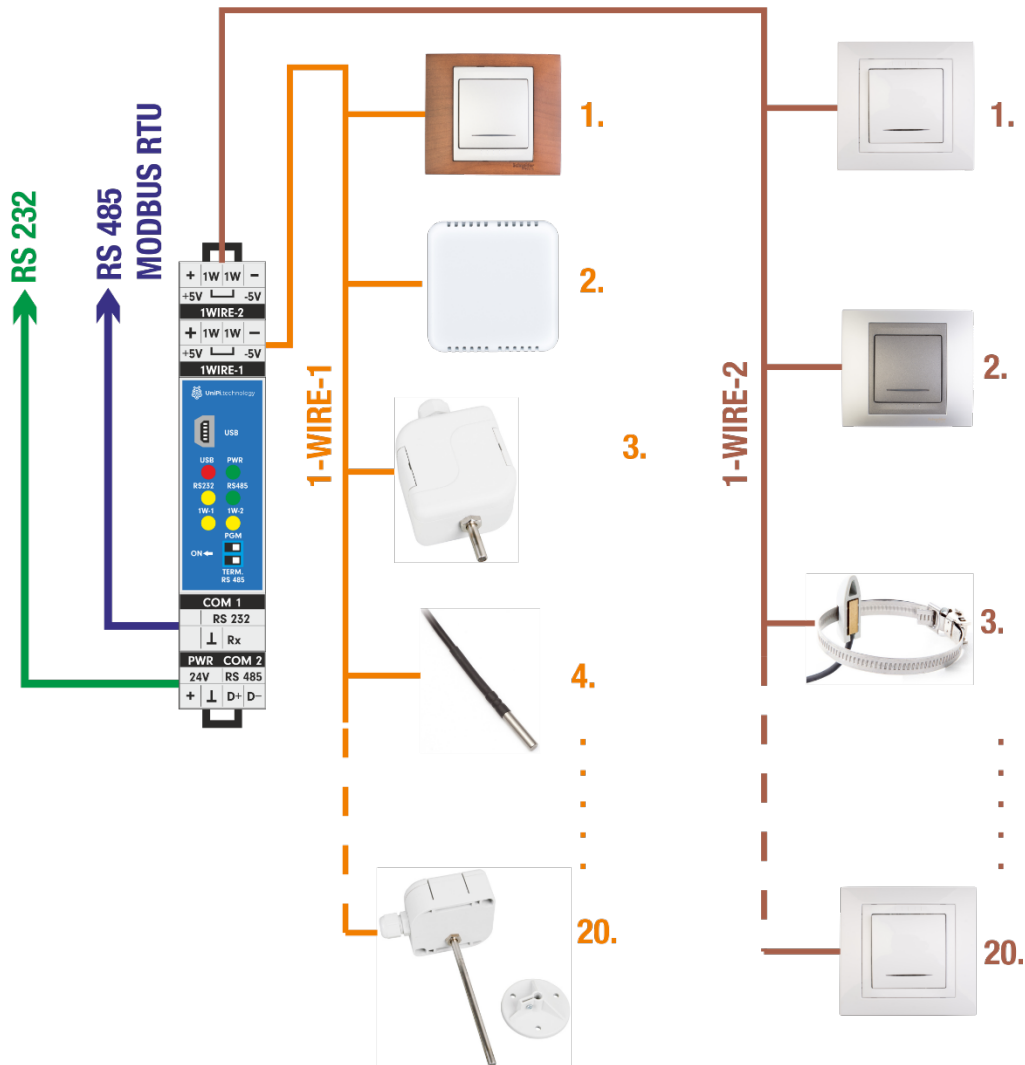

Pic. Connection example of the interfaces

CONNECTION OF POWER SUPPLY 24V, DC

The power supply of the device is 8-27V (DC) with tolerance 10%.

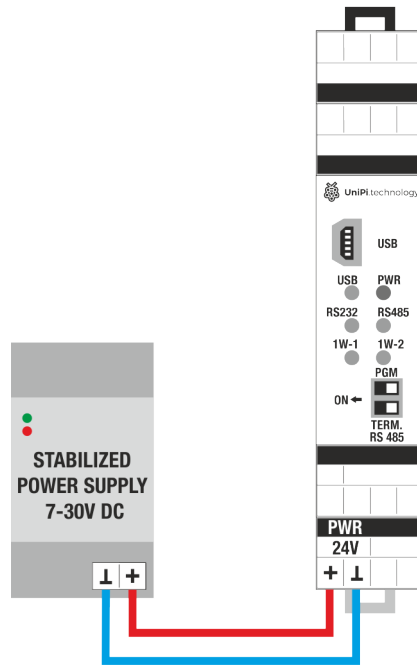

CONNECTION OF COMMUNICATION RS 485

The gateway can communicate through buses RS 485 and RS 232 at the same time.

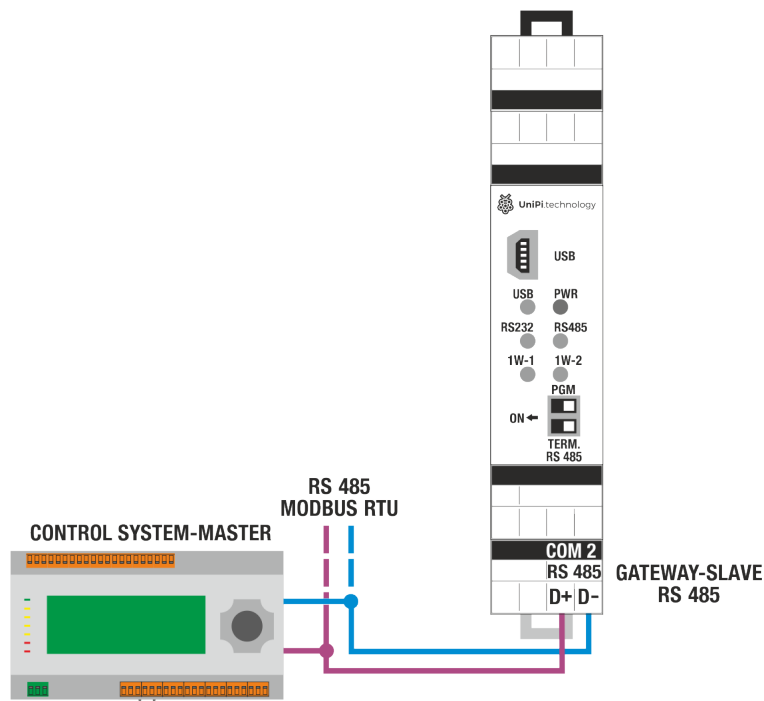

LOAD OF THE BUS RS 485 (TERMINATOR) BLOCK SCHEMA:

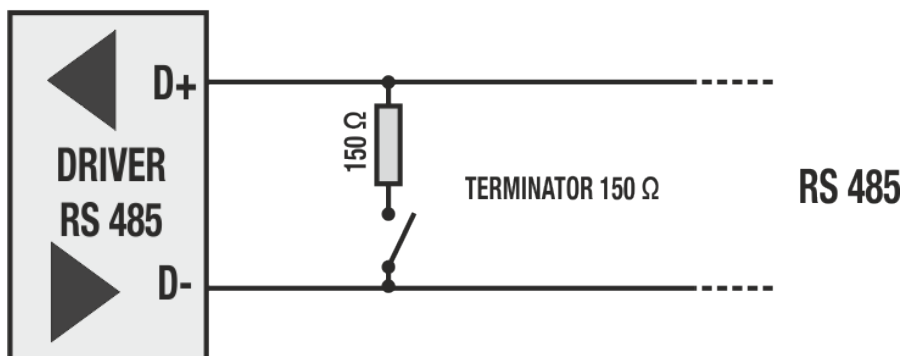

LOAD OF THE BUS RS 485 (TERMINATOR) SELECTION ON/OFF:

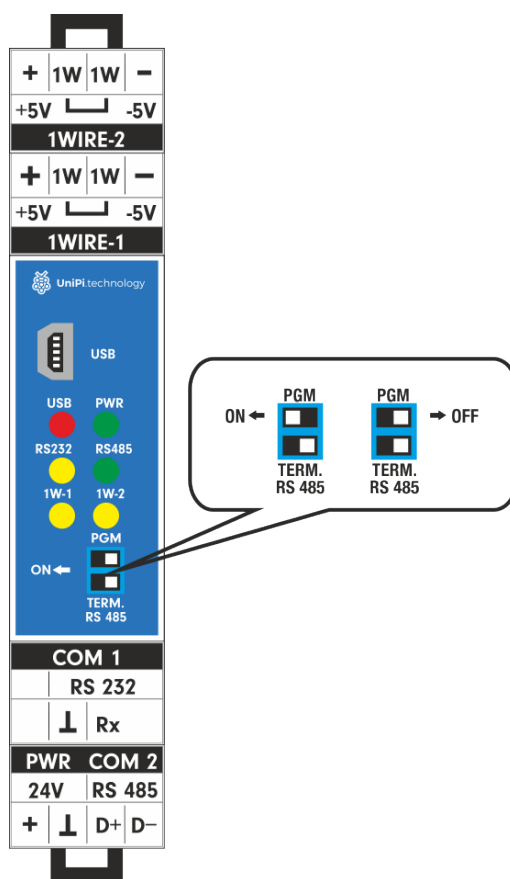

BAUD RATE SETTINGS OF THE COMMUNICATION RS 485:

Baud rate settings of communication and address for RS 485 is made in the application 1-WIRE-GWY Tool in port settings:

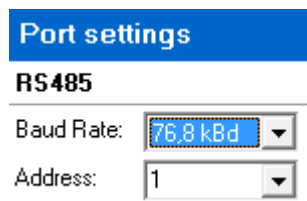

CONNECTION OF COMMUNICATION RS 232

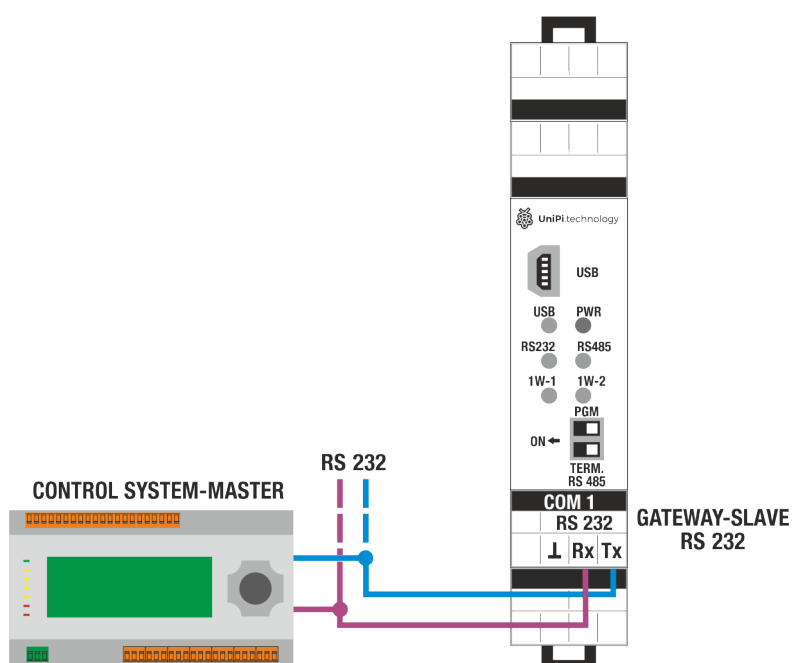

BAUD RATE SETTINGS OF COMMUNICATION RS 232:

Baud rate settings of communication and address for RS 232 is made in the application 1-WIRE-GWY Tool in port settings:

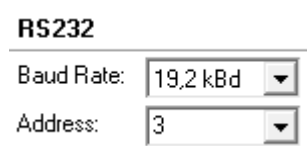

EXAMPLE CONNECTION OF SENSORS ON 1-WIRE

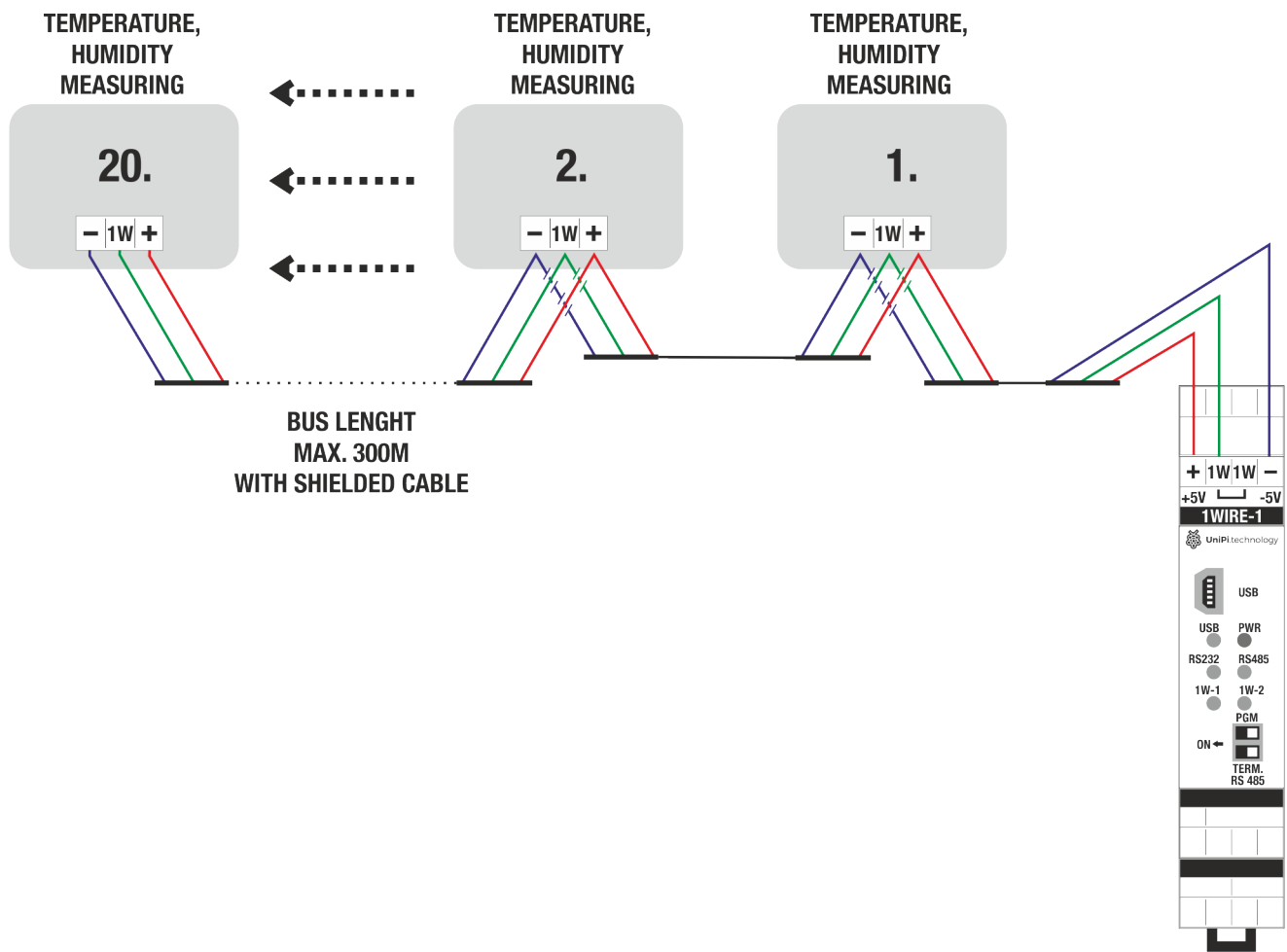

EXAMPLE FOR CONNECTION OF 1-WIRE I-BUTTON READER

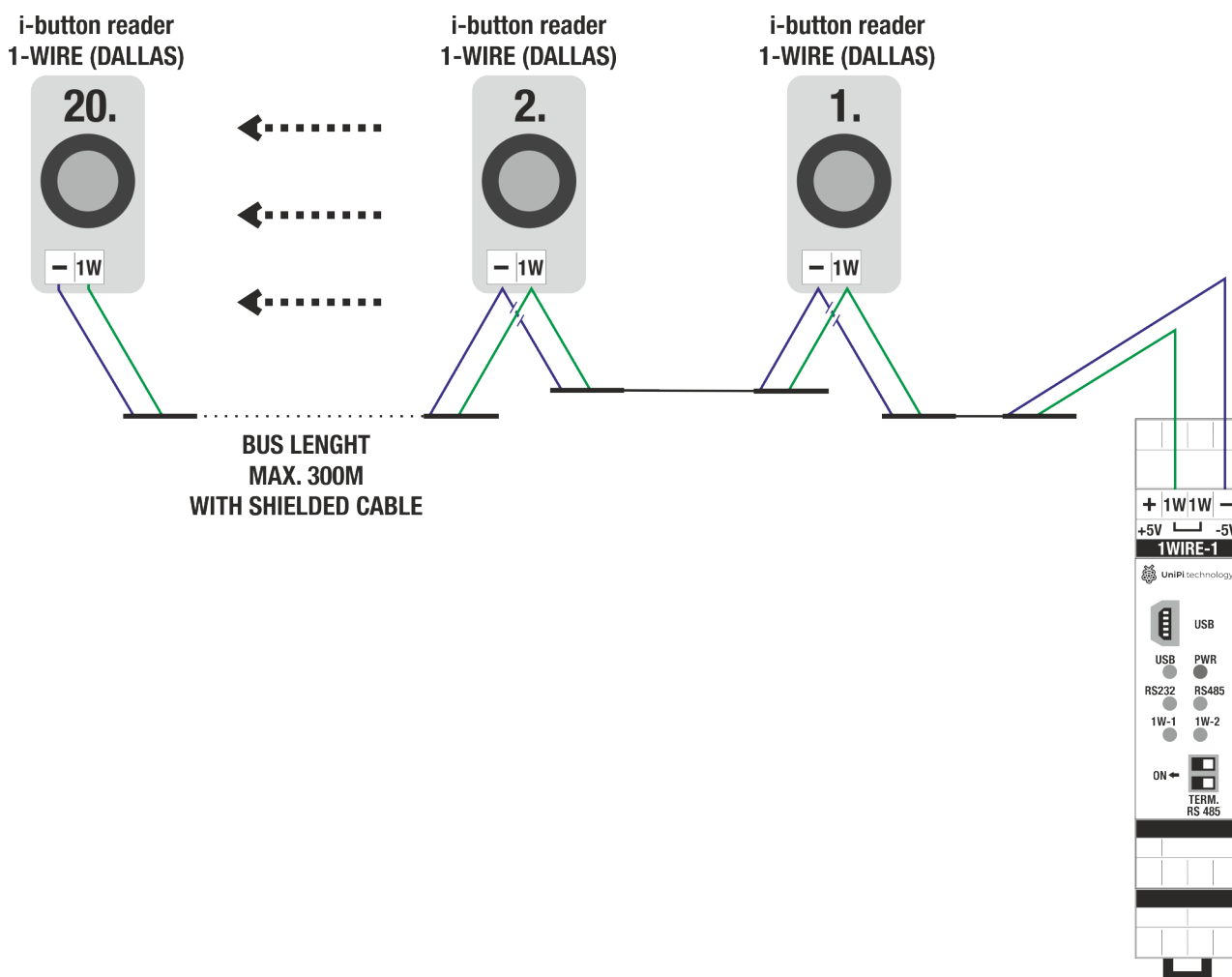

Notice for i-button keys:

Continuous communication runs between gateway and sensors on buses 1-WIRE-1 and 1-WIRE-2 in case of using 1-WIRE sensors. On the contrary in case of using i-button keys, the i-button reader is used as a reading medium and it waits for attaching an i-button key and after that, the communication runs and gateway performs the instruction.

In case of connection of more i-button readers on one bus by the gateway and a user attaches i-button keys by more i-button readers at the same time, so the communication from the readers will overlap.

It is appropriate to think if such a situation may happen. The i-button readers can be divided into both buses or the application can be extended with one another gateway.

Important notice:

It is not able to combine temperatures with i-button readers on one bus (1-WIRE-1 or 1-WIRE-2). The technical combination of temperature sensors and i-button keys is not possible! We recommend the division to the buses 1-WIRE-1 or 1-WIRE-2.

Reading the i-button key on the position in the gateway:

When reading the i-button key on the position in the gateway, the i-button key must be attached to the i-button reader. The i-button reader does not have identification!

CONFIGURATION AND GATEWAY SETTINGS

Gateway settings, all necessary management is solved with the application 1-WIRE-GWY-Tool.

The application ensures:

- **Communication through USB**
- **Configuration of baud rate and address for RS 232, RS 485**
- **Easy adding and removing on/from the position of the 1-WIRE humidity sensor**
- **Easy adding and removing on/from the position of the 1-WIRE i-button key**
- **The option to look up other unknown sensors and adding on position**
- **A comprehensive overview of all measured values, states, errors**
- **Upgrade of gateway's firmware**

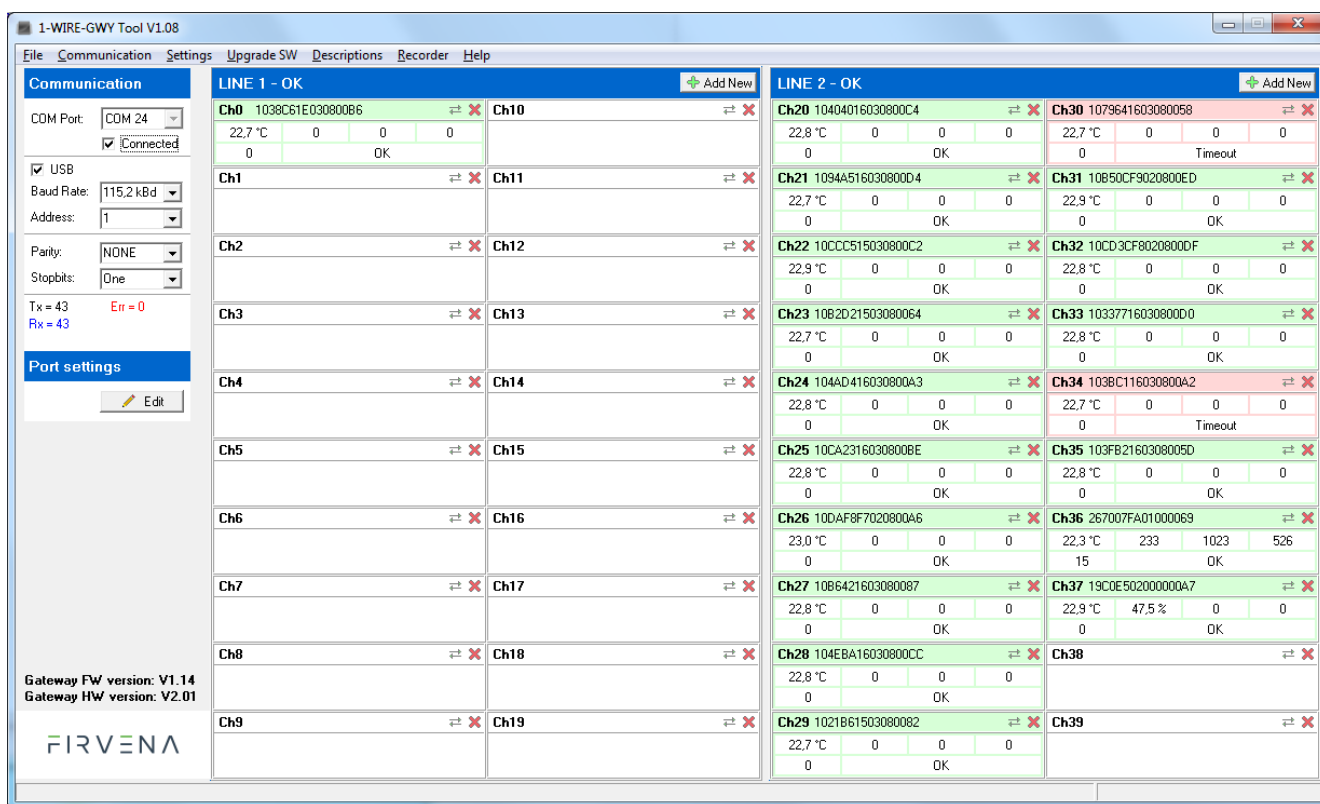

UPGRADE OF FIRMWARE:

Described in a separate document.

1. Register MAP

	No	Description	
Device 1	0	ROM code1 (family code, serial number)	
	1	ROM code2 (serial number)	
	2	ROM code3 (serial number)	
	3	ROM code4 (serial number, CRC)	
	4	Value 1 (Temperature in °C)	
	5	Value 2	
	6	Value 3	
	7	Value 4	
	8	Value 5	
	9	Error	
Device 2	10	ROM code1 (family code, serial number)	
	11	ROM code2 (serial number)	
	12	ROM code3 (serial number)	
	13	ROM code4 (serial number, CRC)	
	14	Value 1 (Temperature in °C)	
	15	Value 2	
	16	Value 3	
	17	Value 4	
	18	Value 5	
	19	Error	
	...		
Device 40	390	ROM code1 (family code, serial number)	
	391	ROM code2 (serial number)	
	392	ROM code3 (serial number)	
	393	ROM code4 (serial number, CRC)	
	394	Value 1 (Temperature in °C)	
	395	Value 2	
	396	Value 3	
	397	Value 4	
	398	Value 5	
	399	Error	
	...		
Service registers	1000	SW Version	
	1001	MODBUS address	PORT RS485
	1002	Baud rate (1200,..115200)	
	1003	MODBUS address	PORT RS232
	1004	Baud rate (1200,..115200)	
	1005	Stop bit 1, 2	PORT RS485
	1006	Parity 0- none, 1 - ODD, 2-EVEN	
	1007	Stop bit 1, 2	PORT RS232
	1008	Parity 0- none, 1 - ODD, 2-EVEN	
	1009	HW Version	
	1010	Command	LINE 1
	1011	Status	
	1012	NEW ROM code1 (family code, serial number)	
	1013	NEW ROM code2 (serial number)	
	1014	NEW ROM code3 (serial number)	
1015	NEW ROM code4 (serial number, CRC)		
	...		
1020	Command	LINE2	
1021	Status		
1022	NEW ROM code1 (family code, serial number)		
1023	NEW ROM code2 (serial number)		
1024	NEW ROM code3 (serial number)		

	1025	NEW ROM code4 (serial number, CRC)	
	1053	Time delay 0 - 200ms	PORT RS485
	1054	Time delay 0 - 200ms	PORT RS232
	1055	Power 1Wire lines (0-OFF, 1- ON, 2,3, .. 5) (default 1-ON)	

	No	Description		
Service registers	1100	ROM code1 (family code, serial number)	LINE 1	
	1101	ROM code2 (serial number)		
	1102	ROM code3 (serial number)		
	1103	ROM code4 (serial number, CRC)		
	1104	Index 0		
	1105	ROM code1 (family code, serial number)		
	1106	ROM code2 (serial number)		
	1107	ROM code3 (serial number)		
	1108	ROM code4 (serial number, CRC)		
	1109	Index 1		
	...			
	1195	ROM code1 (family code, serial number)		
	1196	ROM code2 (serial number)		
	1197	ROM code3 (serial number)		
	1198	ROM code4 (serial number, CRC)		
	1199	Index 19		
	1200	ROM code1 (family code, serial number)		LINE 2
	1201	ROM code2 (serial number)		
	1202	ROM code3 (serial number)		
	1203	ROM code4 (serial number, CRC)		
	1204	Index 0		
	1205	ROM code1 (family code, serial number)		
	1206	ROM code2 (serial number)		
	1207	ROM code3 (serial number)		
	1208	ROM code4 (serial number, CRC)		
	1209	Index 1		
	...			
	1295	ROM code1 (family code, serial number)		
	1296	ROM code2 (serial number)		
	1297	ROM code3 (serial number)		
	1298	ROM code4 (serial number, CRC)		
	1299	Index 19		
5000	Device 1 - Error counter (crc, timeout) 0-65000 (write 0)	LINE 1		
5001	Device 2 - Error counter (crc, timeout) 0-65000			
...				
5019	Device 20 - Error counter (crc, timeout) 0-65000	LINE 2		
5020	Device 21 - Error counter (crc, timeout) 0-65000			
5021	Device 22 - Error counter (crc, timeout) 0-65000			
...				
5039	Device 40 - Error counter (crc, timeout) 0-65000			

2. Description of registers

It is assigned 10 registers to each sensor. 4 registers with an editable serial number, 5 with reading data and 1 error.

Registers with serial number

Register No.	Higher byte	Lower byte	Note
$n \cdot 10 + 0$	8bit family code	serial number - 1	
$n \cdot 10 + 1$	serial number - 2	serial number - 3	
$n \cdot 10 + 2$	serial number - 4	serial number - 5	
$n \cdot 10 + 3$	serial number 6	serial number - 7	
$n \cdot 10 + 4$	serial number - 8	CRC	

*n is number of channels (input)

Data registers

Register No.	Value	Note
$n \cdot 10 + 5$	Temperature * 10	23,5°C -> 235
$n \cdot 10 + 6$	For DS2438 voltage napětí or 0	UNICA module humidity - voltage
$n \cdot 10 + 7$	For DS2438 current or 0	UNICA module lighting ratio 0-1023(0-100%)
$n \cdot 10 + 8$	Approximate relative humidity	Approximate relative humidity %
$n \cdot 10 + 9$	Status / Configuration	Page 0 MemMap DS2438

*n is number of channels (input)

iButtons

Register No.	Value	Note
$n \cdot 10 + 5$	1 Presence of i-button key	0,1
$n \cdot 10 + 6$	No. of i-button key connection	0 - 65353
$n \cdot 10 + 7$	0	
$n \cdot 10 + 8$	0	
$n \cdot 10 + 9$	1	It holds state 20s after disconnection of i-button key

*n is number of channels (input)

Error register

Register No.	Value	Note
$n \cdot 10 + 9$	1 - 255	State of communication with sensor

*n je číslo kanálu (vstupu)

Error register	
Value	Meaning of value
0	Bus Ok
1	No sensor on the bus (bus is interrupted)
2	Bus short-circuit
3	Type of sensor is not supported
4	Error CRC
5	Error in reply - the sensor is not connected
255	Not occupied position

3. Description of service registers

Registers COMMAND and STATUS are available for each bus for editing field of registers.

Register „**Command**“. It is possible to modify register table with this row. row. The first byte contains the command, second one number of channel. Channels are number from zero.

Register No.		Register description
Bus 1	Bus 2	
1010	1020	Command

Example:

Command - meaning of values			
Value in register	Command HiByte	Command LoByte	Description of command
0x0F02	0x0F	0x02	Delete sensor on position 2
0x05FF	0x05	FF=no	Search new ROM Code The command is used when one device only in on the bus
0x06FF	0x06	FF=no	Search ROM Code of all known devices that are connected to the bus
0x07FF	0x07	FF=no	Search ROM Code of all devices that are connected to the bus. Also the saved ones.
0x8208	0x8..2	0x08	Newly found ROM Code with index 2 will be saved on position 8*
0x0902	0x09	0x02	Save new ROM Code on position 2

*Attention, on the second bus the position 20 on position 20 is 0x9414

Register „**Status**“. This register contains respond on „**Command**“.

Register No.		Register description
Bus 1	Bus 2	
1011	1021	Status

- After finishing the command, the number 0xFFFF runs
- If an error occurs during command, the number of error (0xEEE0...A) returns to register status.

Status - meaning of values	
0xFFFF	Command ran without error
0xEEE1	Number of the channel is out of range for the appropriate bus
0xEEE2	Number of commands is not supported
0xEEE3	Error during reading ROM-CODE
0xEEE4	Error Chyba CRC during reading ROM-CODE

Register „**NEW ROM code**“. It will be written read ROM code into such marked registers. After command 0x5FF. Only one set of registers is for each bus.

Register No.		Register description	
Bus 1	Bus 2	Higher byte	Lower byte
1012	1022	8bit family code	serial number - 1
1013	1023	serial number - 2	serial number - 3
1014	1024	serial number - 4	serial number - 5
1015	1025	serial number - 6	serial number - 7

1016	1026	serial number - 8	CRC
------	------	-------------------	-----

Register „Statistics“. It will be written read ROM code into such marked registers. After command 0x5FF. Only one set of registers is for each bus.

Register No.			Register description
PORT1	PORT2	PORT2	
1030	1040	1050	Number of received messages
1031	1041	1051	Number of sent messages
1032	1042	1052	Number of error messages

Register No.	Description
1053 (1054)	The setting of time - delay
	The gateway waits for some time with sending respond after receiving the message from the master. This time consists of basic time (for baud rate 9600 it is 4 ms) and set value time delay. Some devices need longer time for switching from sending to receiving. When time is longer before sending respond, it can solve this problem.
1055	Both buses have the same power supply. This power supply is with DC-DC separated from communication ports, USB and main power supply. If there is a problem with sensors on the bus, one of the option to run communication again maybe a short-term disconnection from the power supply. Disconnection from the power supply is controlled with register 1055. Following options are offered: 0 - Disconnection from the power supply 1 - Connected to the power supply (Default) 2 - Connected to the power supply. If a sensor shows 3x in a row timeout or error, it will happen disconnection from the power supply for approximately 5 s and then connection. Another disconnection for 5 s and connection can be in one minute. 3 - The same as point 2. The difference is that another disconnection for 5 s and connection can be in 5 minutes (default 3). 4 - The same as point 2. The difference is that another disconnection for 5 s can be in 10 minutes. 5 - The same as point 2. The difference is that another disconnection for 5 x can be in 15 minutes.
	If i-button is used on a bus, set the register 1055 on value 1!!!

Registers for newly found sensors. When using commands for searching new sensors the results are saved into the following table.

	No	Description	
Service registers	1100	ROM code1 (family code, serial number)	LINE 1
	1101	ROM code2 (serial number)	
	1102	ROM code3 (serial number)	
	1103	ROM code4 (serial number, CRC)	
	1104	Index 0	
	1105	ROM code1 (family code, serial number)	
	1106	ROM code2 (serial number)	
	1107	ROM code3 (serial number)	
	1108	ROM code4 (serial number, CRC)	
	1109	Index 1	
	...		
1195	ROM code1 (family code, serial number)		

1196	ROM code2 (serial number)	
1197	ROM code3 (serial number)	
1198	ROM code4 (serial number, CRC)	
1199	Index 19	
1200	ROM code1 (family code, serial number)	LINE 2
1201	ROM code2 (serial number)	
1202	ROM code3 (serial number)	
1203	ROM code4 (serial number, CRC)	
1204	Index 0	
1205	ROM code1 (family code, serial number)	
1206	ROM code2 (serial number)	
1207	ROM code3 (serial number)	
1208	ROM code4 (serial number, CRC)	
1209	Index 1	
...		
1295	ROM code1 (family code, serial number)	
1296	ROM code2 (serial number)	
1297	ROM code3 (serial number)	
1298	ROM code4 (serial number, CRC)	
1299	Index 19	

Adding new device (sensor)

You can add a new sensor in two ways:

1. Empty bus
 - The new sensor is connected to an empty bus.
 - ROM code of this sensor is read by writing value 0x05FF into the register 1010 for the bus 1 or 1020 for the bus 2. (numbering from zero)
 - Read number is saved by writing value 0x09nn into the register 1010 (or 1020). The position is determined by the number in hex.
2. Occupied bus
 - The new sensor is connected to the bus with connected sensors.
 - By writing a value into the register 1010 (or 1020), all new ROM codes of sensors (max. 20) that are not saved yet, occur
 - New codes occur in registers 1100 – 1199. 5 registers are assigned for each new sensor. Always the 5th register displays the position.
 - The newfound sensor is written on an appropriate position by writing a value (e.g. 0x8208). The value consists of as follows. Higher byte displays position + 128 (in 1100-1199) from which ROM code is selected. Lower byte is position on which it is saved.
 - Example: 1100 – 1104 is zero position (0x80), 1105 – 1109 is first position (0x81).. etc.
 - If I want to save the first position on position 12, the value is written into the register 1010 will look like as follows: 0x810C.
 - Indicator LED indicating state on bus flickers during searching.

No	Description		COMMAND	No	Description	
1100	ROM code1 0x28B0	Index 0		0	ROM code1 0x10DA	Index 0
1101	ROM code2 0x0E59			1	ROM code2 0xF8F7	
1102	ROM code3 0x0700			2	ROM code3 0x0208	
1103	ROM code4 0x008A			3	ROM code4 0x00A6	
1104	Index 0			4	Value 1	
1105	ROM code1 0x1094	Index 1		5	Value 2	
1106	ROM code2 0xA516			6	Value 3	
1107	ROM code3 0x0308			7	Value 4	
1108	ROM code4 0x00D4			8	Value 5	
1109	Index 1			9	Error	
1110	ROM code1	Index 2		10	ROM code1 0x1094	Index 1
1111	ROM code2			11	ROM code2 0xA516	
1112	ROM code3			12	ROM code3 0x0308	
1113	ROM code4			13	ROM code4 0x00D4	
1114	Index 2			14	Value 1	
1115	ROM code1	Index 3		15	Value 2	
1116	ROM code2			16	Value 3	
1117	ROM code3			17	Value 4	
1118	ROM code4			18	Value 5	
1119	Index 3			19	Error	

Found serial numbers on bus 1 cannot be written on bus 2 and the contrary.

Bus 1				Bus 2			
Position from	Position where	Result value in hex.	Result value in Dec.	Position from	Position where	Result value in hex.	Result value in Dec.
0	0	8000	32768	20	20	9414	37908
1	1	8101	33025	21	21	9515	38165
2	2	8202	33282	22	22	9616	38422

3	3	8303	33539	23	23	9717	38679
4	4	8404	33796	24	24	9818	38936
5	5	8505	34053	25	25	9919	39193
6	6	8606	34310	26	26	9A1A	39450
7	7	8707	34567	27	27	9B1B	39707
8	8	8808	34824	28	28	9C1C	39964
9	9	8909	35081	29	29	9D1D	40221
10	10	8A0A	35338	30	30	9E1E	40478
11	11	8B0B	35595	31	31	9F1F	40735
12	12	8C0C	35852	32	32	A020	40992
13	13	8D0D	36109	33	33	A121	41249
14	14	8E0E	36366	34	34	A222	41506
15	15	8F0F	36623	35	35	A323	41763
16	16	9010	36880	36	36	A424	42020
17	17	9111	37137	37	37	A525	42277
18	18	9212	37394	38	38	A626	42534
19	19	9313	37651	39	39	A727	42791

Example:

New ROM code is displayed in registers 1200-1203. It is such a data in the register 1204 that shows us it is 20th position.

So we will write COM code from the position **20** on position **33**.

For calculation it is possible to use the following formula:

Result value = (Position from + 128) * 256 + Position where

Result value = **(20+128)*256+33**

Result value = 37921 = 9421 Hex